

MILLIAMP CALIBRATOR POCKETCAL™ 134-2

- **CALIBRATES ALL MILLIAMP INSTRUMENTS**
Source milliamps
Simulate two-wire transmitters
Read milliamp outputs
Power & Measure two-wire transmitters
- **COMPACT AND LIGHTWEIGHT**
Fits easily into your pocket
Weighs less than half a pound
- **EASY TO USE**
Turn it on and start calibrating
- **ACCURACY TO ±0.08%**
Within ±0.03 mA from 4 to 20 mA
- **LONG LASTING ALKALINE BATTERIES**
Two "9V" Alkaline batteries last many shifts
- **"QUIK-CHEK®" PUSHBUTTONS**
Instantly output 4.00 and 20.00 milliamps
- **MILLIAMP OR PERCENT DISPLAY**
Source or Read from 0.00 to 24.00 mA or from -25.0 to +125.0% of 4 to 20 mA span



GENERAL INFORMATION

EASY TO USE

The Altek POCKETCAL 134-2 will check, calibrate and measure all your current signal instruments in a 4 to 20 milliamp DC loop. Use at every point in your loop. Source & Read 0.00 to 24.00 mA, Simulate a Two-Wire Transmitter or use the POCKETCAL 134-2 to simultaneously Power & Measure your Two-Wire Transmitters. Toggle the display to show milliamps or percent of 4 to 20.

SOURCE MILLIAMPS

Calibrate recorders, digital indicators, stroke valves or any other instruments that get their input from a 4 to 20 mA loop. Easily set any value to within 0.01 mA with the speed sensitive digital potentiometer.

RECALL OUTPUT SETTINGS

The "QUIK-CHEK" pushbuttons provide rapid checking of 4.00, 20.00 and a third point between 0.00 to 24.00 mA.

CALIBRATE USING LOOP POWER

Check loop wiring and receivers by using the Model 134-2 in place of a 2-Wire transmitter. Simulate a changing process input to check loop response and control settings. The POCKETCAL 134-2 uses any loop power from 3 to 45V DC.

READ LOOP CURRENT

Check controller outputs or measure the milliamp signal anywhere in the loop. The Model 134-2 measures 0.00 to 24.00 mA signals with much greater accuracy than a typical multimeter. Toggle the display to show milliamps or percent of 4 to 20.

POWER & MEASURE 2-WIRE TRANSMITTERS

Simultaneously measure the output of a 2-Wire Transmitter while using the internal batteries to supply up to 14V DC to power the transmitter. Handy for checking transmitters in the field or on the bench.



OPERATING INSTRUCTIONS

GENERAL

TURN-ON



Each time you turn on the POCKETCAL 134-2 the LCD will display all segments for about 1 second. Move the slide switch to the left to select SOURCE or POWER TRANSMITTER. Move the slide switch to the right to select READ or 2-WIRE SIMULATOR.



Press the MODE push-button to toggle between SOURCE and POWER TRANSMITTER or between READ and 2-WIRE SIMULATOR.

SELECTING mA or %



Press the mA/% pushbutton to toggle between 0.00 to 24.00 mA or -25.0 to 125.0% of 4 to 20 mA. When scaled in percent, 100.0% corresponds to 20.00 mA and 0.0% corresponds to 4.00 mA.

TURN OFF

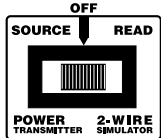

Move the slide switch to OFF to turn the 134-2 off. If AUTO-OFF is enabled, the 134-2 will turn itself off after 30 minutes of inactivity. Move the slide switch to OFF and to the right or left to turn the 134-2 back on.

CHANGING BATTERIES

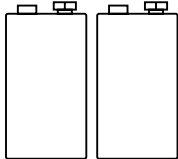

Low battery is indicated by BAT on the display. Approximately four hours of operation remain before the LCD blanks and POCKETCAL 134-2 shuts itself down. Turn the 134-2 off, loosen the captive screws securing the rear cover and lift off the cover from the top of the case. The two "9V" batteries are easily removed and replaced (alkaline supplied and recommended). Replace the bottom cover and tighten the screws.

USER OPTIONS

AUTO-OFF

POCKETCAL 134-2 can be set up to turn itself off after 30 minutes of inactivity. The internal timer is reset to 30 minutes each time a pushbutton is pressed or the knob is dialed. This configuration is part of the DEFAULT SETTINGS below.

DEFAULT SETTINGS - USER OPTIONS (AUTO-OFF)

POCKETCAL 134-2 may be restored to the factory settings. This will reset the SET "QUIK-CHEK" memory to midrange (12 mA). Prompts also guide you for selection of AUTO-OFF.

- 1) Press and hold the SET push-button while turning the 134-2 on.
- 2) Keep pressing the SET push-button until the firmware revision displays (about 5 seconds) then release.
- 3) The words BAT and ON will appear on the display indicating that AUTO-OFF is selected.
- 4) To toggle the AUTO-OFF function on and off press the MODE push-button and the words on and off will display.
- 5) After five seconds the 134-2 will automatically store your choice and the 134-2 will begin normal operation. Or you may press the SET button to accept your choice and begin operation.

SOURCE MILLIAMPS or 2-WIRE SIMULATOR

Select SOURCE to output from 0.00 to 24.00 milliamps using the internal batteries as the power source. Select 2-WIRE SIMULATOR to control the current in loop that has an operating power supply. To change the output value turn the speed sensitive digital potentiometer (knob). The faster it is turned, the faster the output will change. This function operates in all three output positions (HI, SET & LO).

RECALLING QUIK-CHEK OUTPUTS

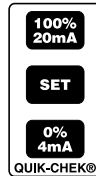

Instantly output 4.00 or 20.00 mA by pressing the 4mA/0% or 20mA/100% push-buttons. For fast three point checks press the SET push-button. The POCKETCAL 134-2 automatically remembers the last SET value, even with the power off.

Note: The same value is stored for both mA and %. The recalled value will be displayed in the units you have selected.

OPEN LOOPS

The digits on the LCD will flash if there is an open loop or if the polarity is reversed. Check all the connections in the loop or try reversing the leads.

POWER TRANSMITTER

Select POWER TRANSMITTER to supply the 12V DC to power a two wire transmitter while simultaneously displaying the 4 to 20 mA output of the transmitter.

OUT OF RANGE SIGNALS



Signals above or below those available for the currently selected range will be indicated by Or and Ur on the display.

READ MILLIAMPS

Select read by moving the slide switch to the right and pressing the MODE pushbutton until the word READ appears on the LCD display.

OUT OF RANGE SIGNALS



Signals above or below those available for the currently selected range will be indicated by Or and Ur on the display.

SETTING UP VALVES

When setting up a valve it is important to correctly set the end stops. Use the 134-2 to supply the 4 to 20 mA control signal to stroke the valve. Select SOURCE to output using the internal batteries as the power source or 2-WIRE SIMULATOR to stroke the valve using an external power supply.

- 1) Disconnect the 4-20 mA control wires from the Current-to-Pressure (I/P) converter or the actuator.
- 2) Connect the 134-2 following the connection diagrams on the next page for SOURCE or SIMULATE 2-WIRE TRANSMITTERS.
- 3) Press the 4mA/0% push-button and adjust the fully closed stop on the actuator.
- 4) Turn the 134-2's knob slowly counterclockwise and verify that the actuator and valve don't move. Repeat steps 3 & 4 until no movement is detected.
- 5) Press the 4mA/0% push-button again and turn the 134-2's knob clockwise. The actuator and valve should begin to move.
- 6) Press the 20mA/100% push-button and adjust the fully open stop on the actuator.
- 7) Turn the 134-2's knob slowly clockwise and verify that the actuator and valve don't move. Repeat steps 6 & 7 until no movement is detected.
- 8) Press the 20mA/100% push-button again and turn the 134-2's knob counterclockwise. The actuator and valve should begin to move.

OPERATING INSTRUCTIONS

SOURCE MILLIAMPS

SOURCE mA, SOURCE % (Percent of 4 to 20 mA)

Choose this function to provide an output from 0.00 to 24.00 milliamps. The compliance voltage is a nominal 12 VDC to provide the driving power to your milliamp receivers.

- 1) Disconnect one or both input wires from the device to be calibrated.
- 2) Move the slide switch to the left then press the MODE push-button until SOURCE is displayed.
- 3) Press the mA/% push-button to toggle between mA and %.
- 4) Connect the red SOURCE lead of the calibrator to the plus (+) input of the device and the black SOURCE lead to the minus (-).

Output current is adjusted by turning the knob. Span and Zero outputs are available by using the QUIK-CHEK push-buttons to recall 20.00 & 4.00 mA.

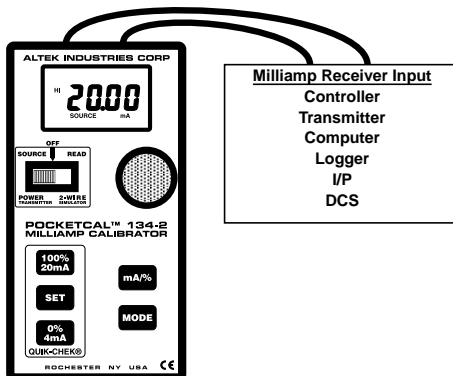

READ MILLIAMP OUTPUTS

READ mA, READ % (Percent of 4 to 20 mA)

Choose this function to measure from 0.00 to +24.00 milliamps or -25.0 to 125.0%.

- 1) Open the current loop at any convenient point along the signal path
- 2) Move the slide switch to the right then press the MODE push-button until READ is displayed.
- 3) Press the mA/% push-button to toggle between mA and %.
- 4) Connect the red READ (+) lead of the calibrator to the more positive point of the break and the black READ (-) lead to the more negative

Signals above or below those available for the currently selected range will be indicated by Or and Ur on the display.

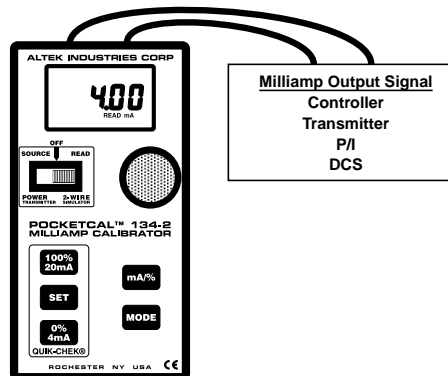

SIMULATE 2-WIRE TRANSMITTERS

2-WIRE mA, 2-WIRE % (Percent of 4 to 20 mA)

Choose this function to simulate a 2-Wire Transmitter output from 0.00 to 24.00 milliamps. Operates in loops with power supply voltages from 3 to 45 VDC.

- 1) Disconnect existing 2-Wire Transmitter from the loop
- 2) Move the slide switch to the right then press the MODE push-button until 2-WIRE is displayed.
- 3) Press the mA/% push-button to toggle between mA and %.
- 4) Connect the red lead of the calibrator to the plus (+) input of the field connections and the black lead to the minus (-)

Loop current is adjustable from 0.00 to 24.00 mA with by turning the knob. Span and Zero outputs are available by using the QUIK-CHEK push-buttons to recall 20.00 & 4.00 mA.

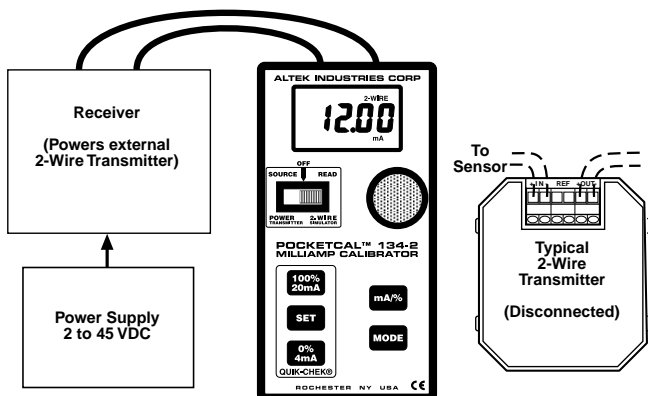

POWER & MEASURE 2-WIRE TRANSMITTERS

PWR XMTR mA, PWR XMTR %

Choose this function to simultaneously supply power to a 2-Wire transmitter while displaying the 4-20 mA output of the transmitter.

- 1) Disconnect one or both input wires from the 2-Wire Transmitter to be calibrated
- 2) Move the slide switch to the left then press the MODE push-button until PWR XMTR is displayed.
- 3) Press the mA/% push-button to toggle between mA and %.
- 4) Connect the red SOURCE lead of the calibrator to the plus (+) input of the device and the black SOURCE lead to the minus (-)
- 5) Connect an appropriate sensor or calibrator to the input of the 2-Wire Transmitter

POCKETCAL 134-2 supplies a nominal 12 Volts DC at 24 mA to the 2-Wire transmitter. The current passed by the transmitter will be accurately displayed by the 134-2. Calibrate the Transmitter in the usual manner and disconnect the 134-2.

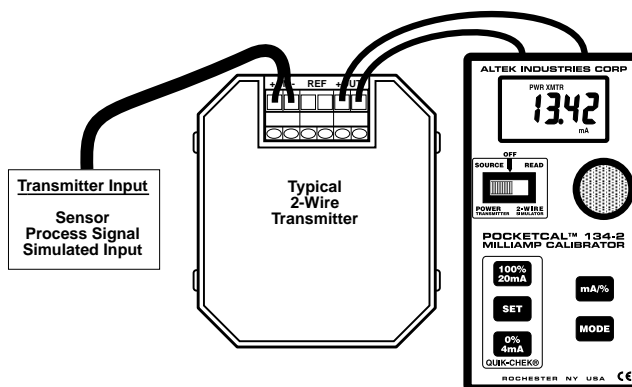

SPECIFICATIONS

(Unless otherwise indicated, specifications are for 1 year in $\pm\%$ of Span @ 23°C)

GENERAL

ACCURACY: $\pm(0.08\%$ of Full Scale + 1 LSD)
WARM UP TIME: 10 seconds to specified accuracy, 2 minutes to maximum accuracy
TEMPERATURE EFFECT: $\pm 0.01\%/^{\circ}\text{C}$ based on $23^{\circ}\pm 25^{\circ}\text{C}$
BATTERIES: Two "9V", (1604) batteries (Alkaline supplied and recommended)
BATTERY LIFE:
SOURCE & POWER TRANSMITTER MODES: Nominal 22 hours at 12 mA, 16 hours at 20 mA with 250 Ohm load
READ & 2-WIRE SIMULATOR MODE: Nominal 40 hours
LOW BATTERY INDICATION: "BAT" indication on the display at approximately 4 hours left
OVERVOLTAGE PROTECTION: Protected to 120V AC/DC for 30 seconds
OPERATING TEMPERATURE RANGE: -5 to +130 °F (-20 to +55°C)
STORAGE TEMPERATURE RANGE: -13 to +130°F (-25 to +55°C)
RELATIVE HUMIDITY: 10 to 90%, non-condensing for 24 hours from 0 to 35°C
OVERALL SIZE: 121.9 x 66.0 x 35.8 mm (4.8 x 2.6 x 1.41 inches)
WEIGHT: 0.22 kg (7.8 oz)

MILLIAMP SOURCE

RANGES: 0.00 to 24.00 mA; -25.0 to 125.0 % of 4 to 20 mA
ACCURACY: $\pm(0.08\%$ of 24 mA Span + 0.01 mA) = 0.03mA
TYPICAL DRIVE CAPABILITY: 700 Ohms @ 20.00 mA with fresh batteries, 300 Ohms @ 20.00 mA with low batteries
COMPLIANCE VOLTAGE: nominal 14V @ 20 mA with fresh batteries

POWER & MEASURE 2-WIRE TRANSMITTERS

RANGES & ACCURACY: Same as for MILLIAMP SOURCE
OUTPUT CURRENT: up to 24.00 mA
TYPICAL DRIVE CAPABILITY: 700 Ohms @ 20.00 mA with fresh batteries, 300 Ohms @ 20.00 mA with low batteries
COMPLIANCE VOLTAGE: nominal 12 VDC @ 20 mA

2-WIRE TRANSMITTER SIMULATOR

RANGES & ACCURACY: Same as for MILLIAMP SOURCE
LOOP VOLTAGE LIMITS: Minimum, 3 VDC; Maximum 45 VDC
OVERLOAD PROTECTION: Current limited to 25 mA nominal

MILLIAMP READ

RANGES & ACCURACY: Same as for MILLIAMP SOURCE
VOLTAGE BURDEN: 0.9V at 4 mA, 1.2V at 20 mA, 1.9V at 24 mA excitation Current

Specifications subject to change without notice

ADDITIONAL INFORMATION

OTHER PRODUCTS

Altek designs and manufactures fast, accurate instruments for measurement, generation and simulation of virtually every process control signal. Consult our factory directly or contact your local stocking representative to order precise, low cost Milliamp Calibrators, Voltage Sources, Thermocouple Sources, RTD Simulators, Frequency Calibrators and Pressure Pumps, Indicators & Calibrators. Altek also produces calibrators for custom ranges and unique applications. New models are frequently added to the Altek family to meet all of your critical calibration requirements. Altek products are made in the USA.

THREE YEAR WARRANTY

Our equipment is guaranteed against defective material and workmanship (excluding batteries and leads) for a period of three years from date of shipment. Claims under guarantee can be made by returning the equipment prepaid to our factory. The equipment will be replaced, repaired or adjusted at our option. The liability of Altek is restricted to that given under our guarantee. No responsibility is accepted for damage, loss or other expense incurred through sale or use of our equipment. Under no condition shall Altek be held liable for any special, incidental or consequential damage.

ORDERING INFORMATION

POCKETCAL Milliamp Calibrator

Part No.

134-2

Included with each Model 134-2 are:

Attached test leads with alligator clips

Data Sheet 134-2

NIST Traceable Certificate and Three Year Warranty

OPTIONAL ACCESSORIES

Carrying Case

Part No.

09-3781

AVAILABLE FROM